

BM SERIES BALL VALVE ACTUATOR

**Modulating Control
10 Nm**



BM...10 (S1) SERIES

BM series standard valve actuators are especially designed and produced for applications in the HVAC systems. Our wide range of standard valve actuators has been developed to operate and position ball valves of different sizes.

PRODUCT FEATURE

- Torque 10 Nm
- Valve size DN40(1½") / DN50(2")
- Power supply AC/DC 24 V / AC2 30V
- Control Modulating DC 0(2)...10 V & DC 0(4)...20 mA
- Shaft dimensions - □ 9.0 mm (fixed)
- Selectable direction of rotation of reversing actuator
- Actuator with 1 m cable connection
- Optional 1 Adjustable SPDT auxiliary switch

MODEL SELECTION TABLE

MODEL / TYPE	TORQUE	POWER SUPPLY	RUNNING TIME	AUXILIARY SWITCH
BM 1.1-10	10 Nm	AC/DC 24 V ± 10%	100...150 sec	-
BM 1.1-10S1	10 Nm	AC/DC 24 V ± 10%	100...150 sec	1 x SPDT (Adjustable)
BM 2.2-10	10 Nm	AC 230V ± 10%	100...150 sec	-
BM 2.2-10S1	10 Nm	AC 230V ± 10%	100...150 sec	1 x SPDT (Adjustable)

DIMENSION (mm)

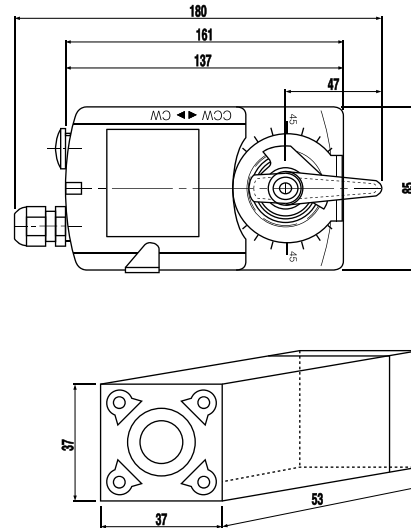
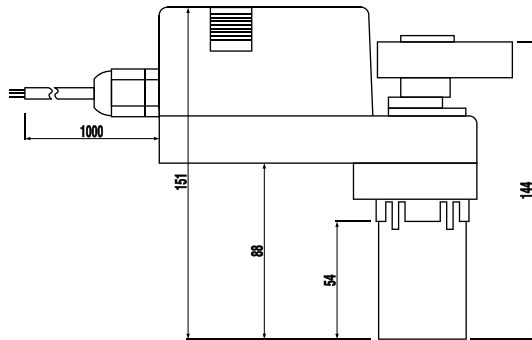

TECHNICAL SPECIFICATION

MODEL NUMBER	BM 1.1-10 (S1)	BM 2.2-10 (S1)
TORQUE	10 Nm	10 Nm
VALVE SIZE	DN40(1½") / DN50(2")	DN40(1½") / DN50(2")
SHAFT DIMENSION	□ 9.0 mm (fixed)	□ 9.0 mm (fixed)
POWER SUPPLY	AC/DC 24 V ± 10%	AC 230 V ± 10%
FREQUENCY	50...60 Hz	50...60 Hz
CONTROL SIGNAL (INPUT)	DC 0(2)...10 V & DC 0(2)...10 V	DC 0(2)...10 V & DC 0(2)...10 V
POSITION SIGNAL (OUTPUT)	DC 0...10 V	DC 0...10 V
POWER CONSUMPTION		
● OPERATING	6.0 W	6.0 W
● END POSITION	4.0 W	4.0 W
FOR WIRE SIZING	6.5 VA	6.5 VA
ELECTRICAL CONNECTION	1 m Cable	1 m Cable
AUXILIARY SWITCH RATING	3 (1.5) A, AC 250 V	3 (1.5) A, AC 250 V
PROTECTION CLASS	Class III ⚡	Class III ⚡
ANGLE OF ROTATION	90° (95° mechanical)	90° (95° mechanical)
WEIGHT	< 1.1 Kg	< 1.2 Kg
LIFE CYCLE	60,000 Rotation	60,000 Rotation
SOUND LEVEL	40 dB	40 dB
IP PROTECTION	IP54	IP54
OPERATING TEMPERATURE	-20°...50° as per IEC 721-3-3	-20°...50° as per IEC 721-3-3
NON-OPERATING TEMPERATURE	-30°...+60° C / IEC 721-3-2	-30°...+60° C / IEC 721-3-2
AMBIENT HUMIDITY	5%...95% rH non condensing / EN	5%...95% rH non condensing / EN
MAINTENANCE	Maintenance Free	Maintenance Free
MODE OF OPERATION	Type I / EN 60730-1	Type I / EN 60730-1
EMC	CE & ISO 9000 EN / EEC	CE & ISO 9000 EN / EEC

BM SERIES BALL VALVE ACTUATOR

**Modulating Control
10 Nm**

WIRING DIAGRAM BM...10 (S1) POWER SUPPLY AC/DC 24V

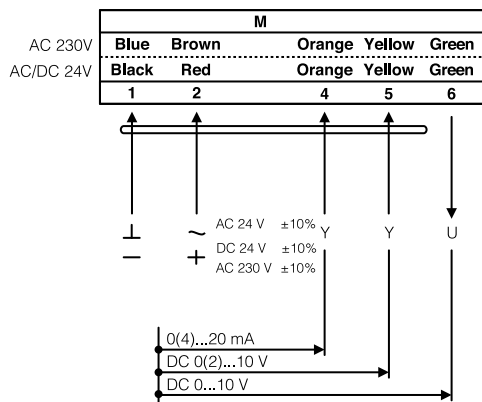

DIRECTION OF ROTATION BM...10 (S1)

Default factory setting: CCW.

Direction of rotation can be changed by toggling between CW/CCW switch on the actuator's housing.

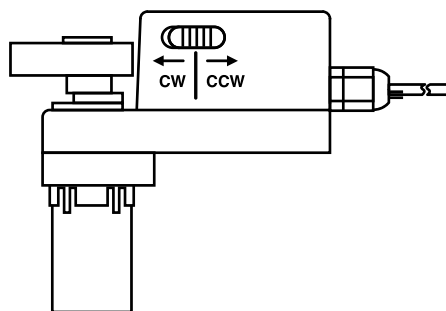

WIRING DIAGRAM BM...10 (S1) AUXILIARY SWITCH

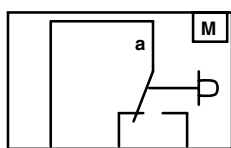

Orange Yellow Green
S1 S2 S2

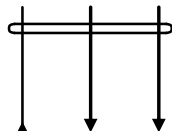

3 (1.5) A, AC 250 V
Actuator at 0° position

AUXILIARY SWITCH BM...10 (S1)

Switch a factory-set at 5°.

The auxiliary switch can be optimally adjusted between 0°...90°.

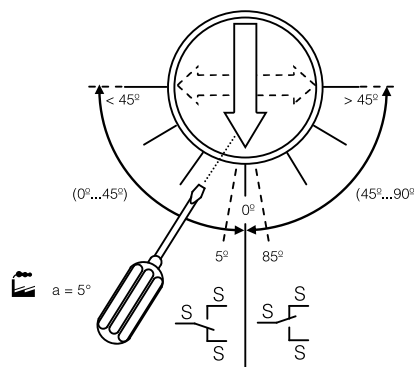

WIRING DIAGRAM BM...10 (S1) PARALLEL CONNECTION

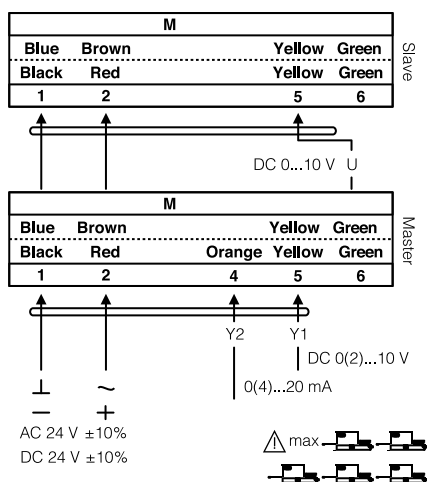

REMARK

During parallel operation, the output signal (terminal 6, DC 0...10 V) of the master actuator must be connected to terminal 5 of the next slave actuator.

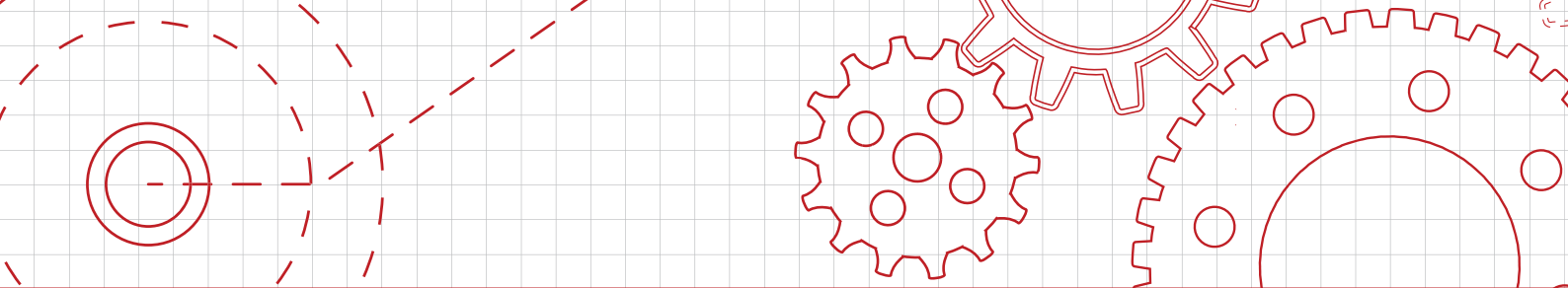

MIXING CLOSED

MIXING OPEN

ACTUATOR POSITION

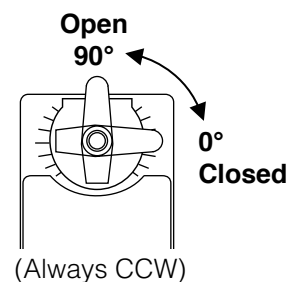
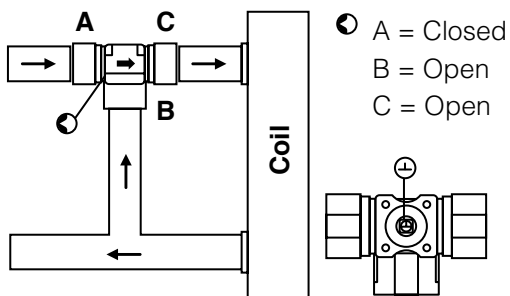
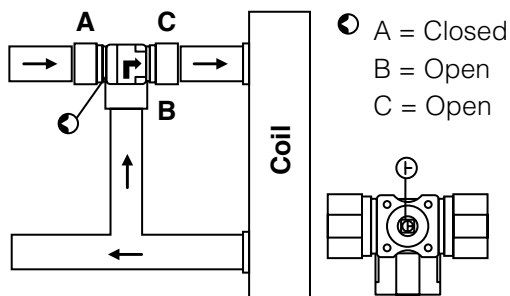

2-way Closed 2-way Open

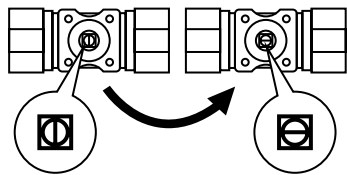

3-way Closed 3-way Open

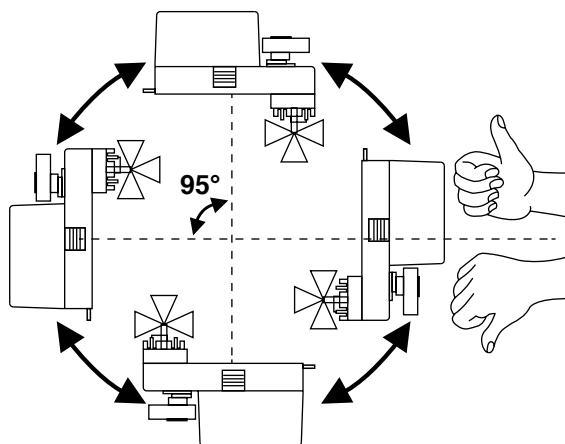
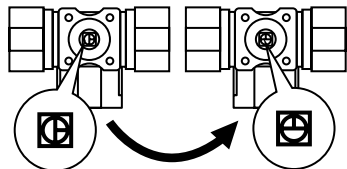

IMPORTANT REMARK

For special requirement, consult your local Swisotec's representative.

This actuator includes electrical and electronic components and may not be disposed as household garbage. Please consider the local valid legislation.

AC / DC 24 V: Connect via safety isolating transformer.
 AC 230 V: To isolate from the main power supply, the system must incorporate a device which disconnects the phase conductor (with at least a 3mm contact gap.)

The performance specifications are nominal and conform to acceptable industry standards. Swisotec shall not be liable for damages resulting from misapplication or misuse of its products.