

CM SERIES STANDARD DAMPER ACTUATOR

**Modulating Control
5 Nm**

CM...05 SERIES

CM standard damper actuators are specially designed and produced for applications in the HVAC Systems. Our wide range of Swisotec standard damper actuators has been developed to operate and position air dampers of different sizes.



PRODUCT FEATURE

- Torque 5 Nm
- Damper size 1.0 m²
- Power supply AC/DC 24V
- Modulating Control Signal DC 0(2)...10 V
- Shaft dimensions - Ø 6...15 mm / □ 5...10.5 mm
- Minimum Shaft Length 40 mm
- Adjustable angle of rotation
- Selectable direction of rotation of reversing actuator
- Actuator with 1 m cable connection
- Manual Over-ride push button when required

MODEL SELECTION TABLE

MODEL / TYPE	TORQUE	POWER SUPPLY	RUNNING TIME	AUXILIARY SWITCH
CM 1.2-05	5 Nm	AC/DC 24 V ± 10%	60...90 sec	-

DIMENSION (mm)

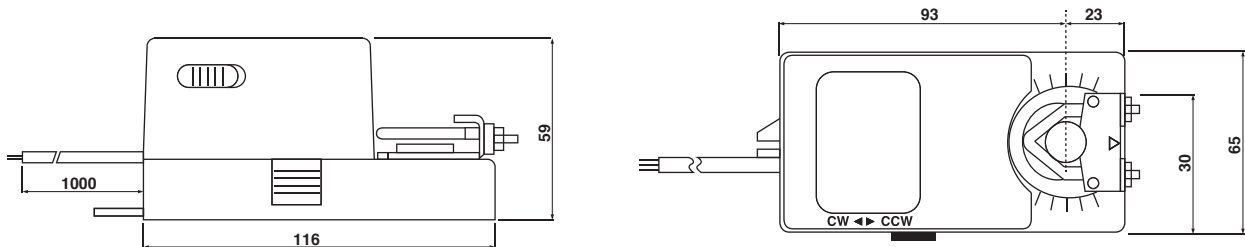

TECHNICAL SPECIFICATION

MODEL NUMBER	CM 1.2-05
TORQUE	5 Nm
DAMPER SIZE	1.0 m ²
SHAFT DIMENSION	Ø 6...15 mm / □ 5...10.5 mm
POWER SUPPLY	AC/DC 24 V ± 10%
FREQUENCY	50...60 Hz
CONTROL SIGNAL (INPUT)	DC 0(2)...10 V
POSITION SIGNAL (OUTPUT)	DC 0...10 V
POWER CONSUMPTION	
● OPERATING	4.0 W
● END POSITION	2.0 W
FOR WIRE SIZING	14.0 VA
ELECTRICAL CONNECTION	1 m Cable
PROTECTION CLASS	Class III ⚡
ANGLE OF ROTATION	90° (95° mechanical)
WEIGHT	< 0.7 Kg
LIFE CYCLE	60,000 Rotation
SOUND LEVEL	40 dB
IP PROTECTION	IP54
OPERATING TEMPERATURE	-20°...50° as per IEC 721-3-3
NON-OPERATING TEMPERATURE	-30°...+60° C / IEC 721-3-2
AMBIENT HUMIDITY	5%...95% rH non condensing / EN
MAINTENANCE	Maintenance Free
MODE OF OPERATION	Type I / EN 60730-1
EMC	CE & ISO 9000 EN / EEC

CM SERIES STANDARD DAMPER ACTUATOR

Modulating Control
5 Nm

WIRING DIAGRAM CM...05 POWER SUPPLY AC/DC 24V

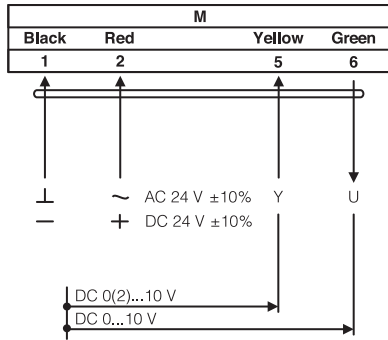

DIRECTION OF ROTATION CM...05

Default factory setting: CW.

Direction of rotation can be changed by toggling between CW/CCW switch on the actuator's housing.

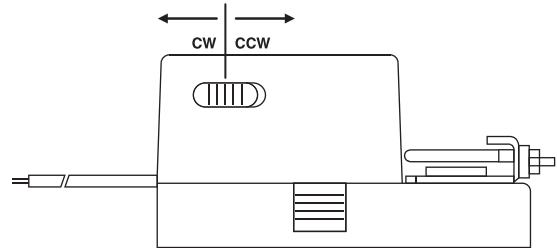

WIRING DIAGRAM CM...05 PARALLEL CONNECTION

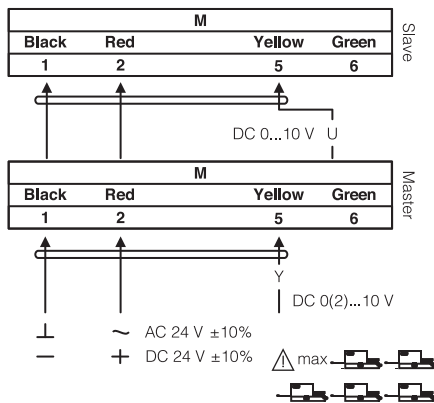

REMARK

During parallel operation, the output signal (terminal 6, DC 0...10 V) of the master actuator must be connected to terminal 5 of the next slave actuator.

RELEASING THE ADAPTER CM...05

Releasing the adapter is not required.

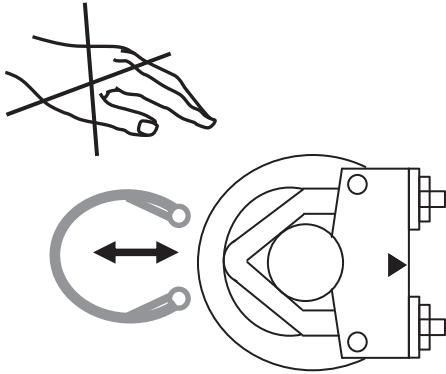

LIMITING ANGLE OF ROTATION CM...05

Adjustment of Mechanical Limiter

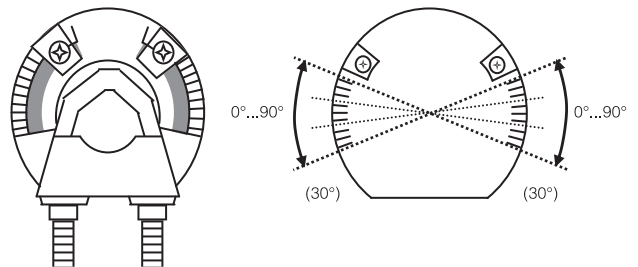

1. Loosen screw of mechanical limiter
2. Move limiter to appropriate position*
3. Tighten screw

*Working range of 90° can be reduced up to 30° from end position.



IMPORTANT REMARK

For special requirement, consult your local Swisotec's representative.

  This actuator includes electrical and electronic components and may not be disposed as household garbage. Please consider the local valid legislation.

 AC / DC 24 V: Connect via safety isolating transformer.
AC 230 V: To isolate from the main power supply, the system must incorporate a device which disconnects the phase conductor (with at least a 3mm contact gap.)

The performance specifications are nominal and conform to acceptable industry standards. Swisotec shall not be liable for damages resulting from misapplication or misuse of its products.