

# ECA SERIES ELECTRONIC RETURN DAMPER ACTUATOR

**2 Point Control**  
**20 Nm**

## ECA...20 SERIES (S)

ECA SERIES damper actuators with Electronic Return® (ER) function are designed and produced for extended functionalities in the HVAC Systems: air handling equipment, fan coils and laboratory applications. Electronic Return® (ER) is able to manage short voltage interruptions for max. 10 seconds.

## PRODUCT FEATURE



- Torque 20 Nm
- Damper size 4.0 m<sup>2</sup>
- Power supply AC/DC 24V and AC 230V
- Shaft dimensions - Ø 12...20 mm / □ 11...14 mm
- Minimum Shaft Length 45 mm
- Adjustable angle of rotation
- Selectable direction of rotation of reversing actuator
- Actuator with 1 m cable connection
- Optional 2 Adjustable SPDT auxiliary switches
- Manual Over-ride push button when required

## MODEL SELECTION TABLE

MODEL /TYPE	TORQUE	POWER SUPPLY	RUNNING TIME	RETURN	AUXILIARY SWITCH
ECA 1-20	20 Nm	AC/DC 24V ± 10%	90...100 sec	70 sec	-
ECA 1-20S	20 Nm	AC/DC 24V ± 10%	90...100 sec	70 sec	2 x SPDT (Adjustable)
ECA 2-20	20 Nm	AC 230V ± 10%	90...100 sec	70 sec	-
ECA 2-20S	20 Nm	AC 230V ± 10%	90...100 sec	70 sec	2 x SPDT (Adjustable)

## DIMENSION (mm)

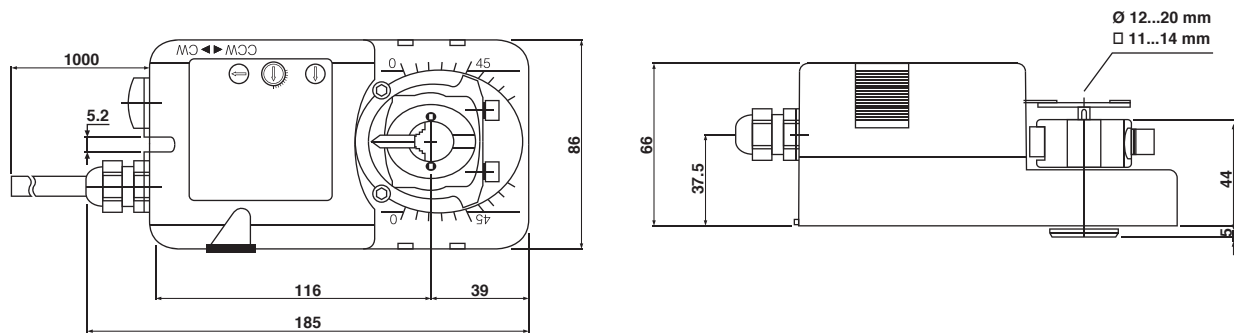

## TECHNICAL SPECIFICATION

MODEL NUMBER	ECA 1-20 (S)	ECA 2-20 (S)
TORQUE	20 Nm	20 Nm
DAMPER SIZE	4.0 m <sup>2</sup>	4.0 m <sup>2</sup>
SHAFT DIMENSION	Ø 12...20 mm / □ 11...14 mm	Ø 12...20 mm / □ 11...14 mm
POWER SUPPLY	AC/DC 24 V ± 10%	AC 230 V ± 10%
FREQUENCY	50...60 Hz	50...60 Hz
CONTROL SIGNAL	2 point control	2 point control
POWER CONSUMPTION		
● OPERATING	7.2 W	7.2 W
● END POSITION	1.2 W	1.2 W
FOR WIRE SIZING	10.0 VA	10.0 VA
ELECTRICAL CONNECTION	1 m Cable	1 m Cable
AUXILIARY SWITCHES RATING	3 (1.5) A, AC 250 V	3 (1.5) A, AC 250 V
PROTECTION CLASS	Class III ⚡	Class II ⚡
ANGLE OF ROTATION	90° (95° mechanical)	90° (95° mechanical)
WEIGHT	1.2 Kg	1.2 Kg
LIFE CYCLE	60,000 Rotation	60,000 Rotation
SOUND LEVEL	< 45 dB (A)	< 45 dB (A)
IP PROTECTION	IP54	IP54
OPERATING TEMPERATURE	-20°...50° as per IEC 721-3-3	-20°...50° as per IEC 721-3-3
NON-OPERATING TEMPERATURE	-30°...+60° C / IEC 721-3-2	-30°...+60° C / IEC 721-3-2
AMBIENT HUMIDITY	5%...95% rH non condensing / EN	5%...95% rH non condensing / EN
MAINTENANCE	Maintenance Free	Maintenance Free
MODE OF OPERATION	Type I / EN 60730-1	Type I / EN 60730-1
EMC	CE & ISO 9000 EN / EEC	CE & ISO 9000 EN / EEC

# ECA SERIES ELECTRONIC RETURN DAMPER ACTUATOR

**2 Point Control**  
**20 Nm**

## WIRING DIAGRAM ECA...20 (S) POWER SUPPLY AC/DC 24 V / AC 230V

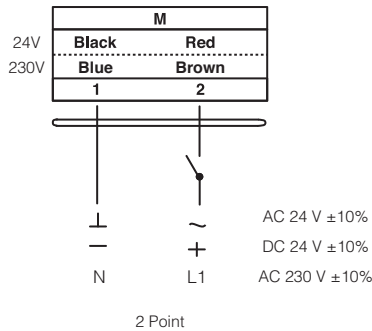

⚠ Connect via safety isolating transformer

## DIRECTION OF ROTATION ECA...20 (S)

Default factory setting: CW.

Direction of rotation can be change by toggling between CW/CCW switch on the actuator's housing.

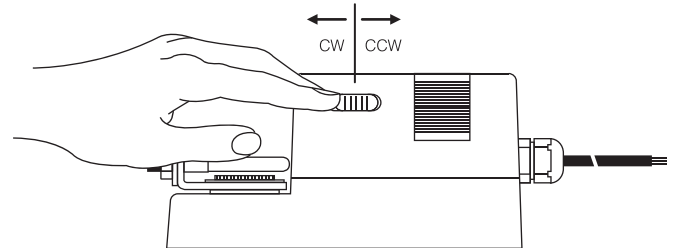

## WIRING DIAGRAM ECA...20 (S) AUXILIARY SWITCH

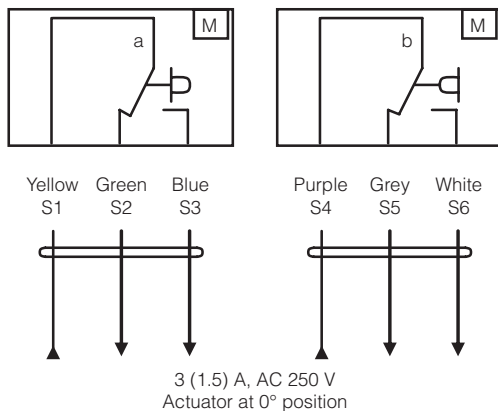

## AUXILIARY SWITCH ECA...20 (S)

Switch **a** factory-set at 5° and 85°.

The auxiliary switch can be optimally adjusted between 0°...90°.

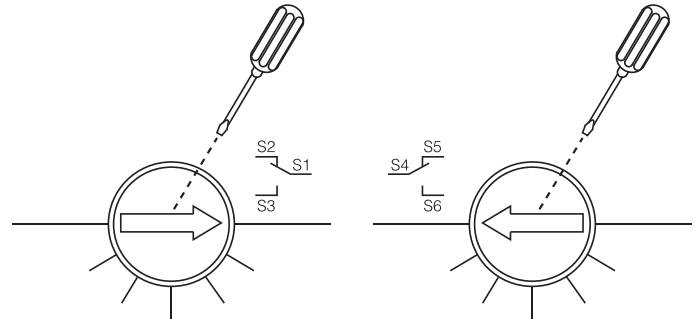

## WIRING DIAGRAM ECA...20 (S) PARALLEL CONNECTION

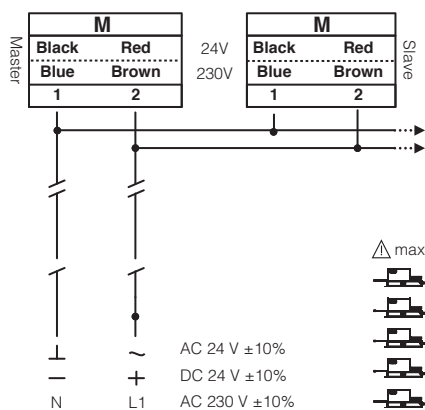

## REMARK

Parallel connection of ECA...20 actuators are limited to 5. Power consumption must be observe.

## ANGLE OF ROTATION LIMITING

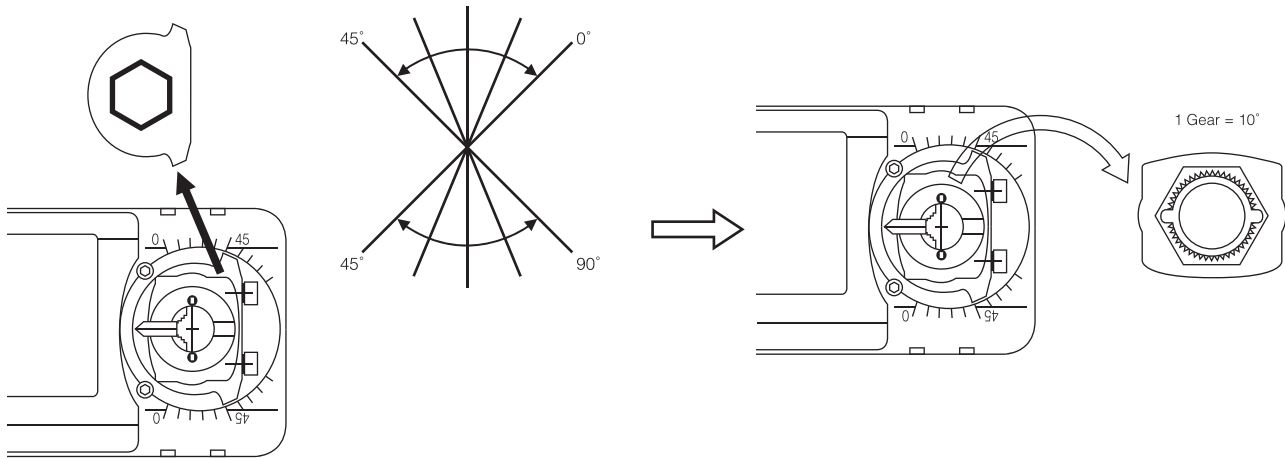

## INSTALLATION / MOUNTING INSTRUCTION

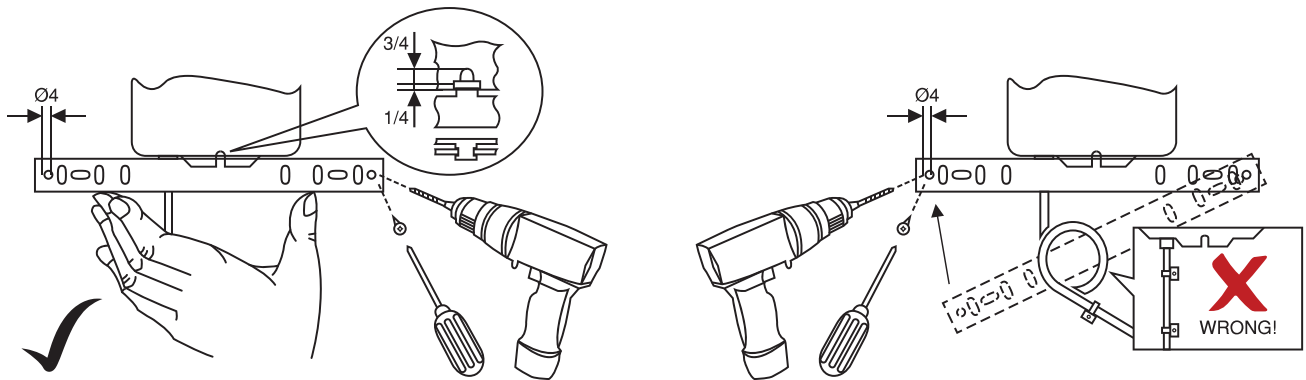

## IMPORTANT REMARK

For special requirement, consult your local Swisotec's representative.



This actuator includes electrical and electronic components and may not be disposed as household garbage. Please consider the local valid legislation.



AC / DC 24 V:  
AC 230 V:

Connect via safety isolating transformer.  
To isolate from the main power supply, the system must incorporate a device which disconnects the phase conductor (with at least a 3mm contact gap.)

The performance specifications are nominal and conform to acceptable industry standards. Swisotec shall not be liable for damages resulting from misapplication or misuse of its products.