

SA SERIES

FAST RUNNING DAMPER ACTUATOR

2 Point & 3 Point Control
20 Nm

SA...20 (S) SERIES

Swisotec is proud to offer the 10 and 20 Nm damper actuator of the SA... 10/20 (S) Series of designed specifically applications into the HVAC and Light Industrial market. Swisotec high quality actuators have been designed for use with fast running air damper and ball valve application.

PRODUCT FEATURE



- Torque 20 Nm
- Power supply AC/DC 24V and AC 230V
- Shaft dimensions - Ø 12...20 mm / □ 11...14 mm
- Minimum Shaft Length 40 mm
- Adjustable angle of rotation
- Selectable direction of rotation of reversing actuator
- Actuator with 1 m cable connection
- Optional 2 Adjustable SPDT auxiliary switches
- Manual Over-ride push button when required
- Collaborate with NVCB 9000 Bracket 1

MODEL SELECTION TABLE

MODEL / TYPE	TORQUE	POWER SUPPLY	RUNNING TIME	AUXILIARY SWITCH
SA 1-20	20 Nm	AC/DC 24 V ± 10%	20 Sec	-
SA 1-20S	20 Nm	AC/DC 24 V ± 10%	20 Sec	2 x SPDT (Adjustable)
SA 2-20	20 Nm	AC 230 V ± 10%	20 Sec	-
SA 2-20S	20 Nm	AC 230 V ± 10%	20 Sec	2 x SPDT (Adjustable)

DIMENSION (mm)

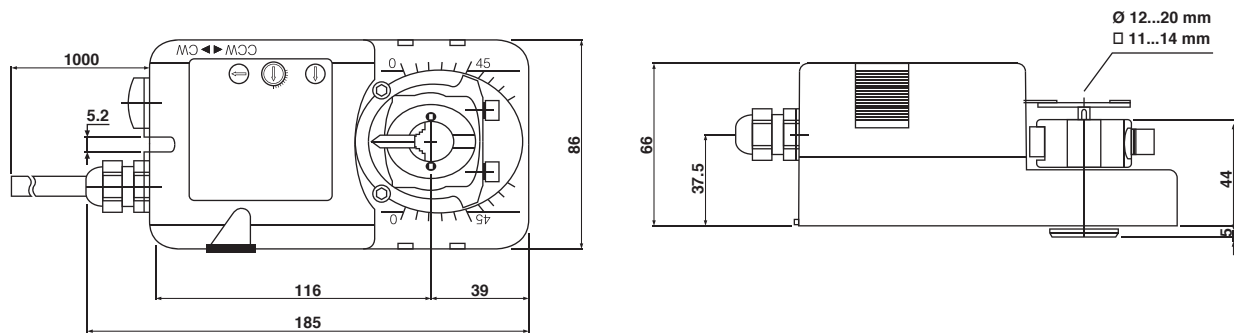

TECHNICAL SPECIFICATION

MODEL NUMBER	SA 1-20 (S)	SA 2-20 (S)
TORQUE	20 Nm	20 Nm
DAMPER SIZE	4.0 m ²	4.0 m ²
SHAFT DIMENSION	Ø 12...20 mm / □ 11...14 mm	Ø 12...20 mm / □ 11...14 mm
POWER SUPPLY	AC/DC 24 V ± 10%	AC 230 V ± 10%
FREQUENCY	50...60 Hz	50...60 Hz
CONTROL SIGNAL	2 & 3 point control	2 & 3 point control
POWER CONSUMPTION		
● OPERATING	8.0 W	8.0 W
● END POSITION	2.0 W	2.0 W
FOR WIRE SIZING	14.0 VA	14.0 VA
ELECTRICAL CONNECTION	1 m Cable	1 m Cable
AUXILIARY SWITCHES RATING	3 (1.5) A, AC 250 V	3 (1.5) A, AC 250 V
PROTECTION CLASS	Class III ⚡	Class II ⚡
ANGLE OF ROTATION	90° (95° mechanical)	90° (95° mechanical)
WEIGHT	1.2 Kg	1.2 Kg
LIFE CYCLE	60,000 Rotation	60,000 Rotation
SOUND LEVEL	45 dB	45 dB
IP PROTECTION	IP54	IP54
OPERATING TEMPERATURE	-20°...50° as per IEC 721-3-3	-20°...50° as per IEC 721-3-3
NON-OPERATING TEMPERATURE	-30°...+60° C / IEC 721-3-2	-30°...+60° C / IEC 721-3-2
AMBIENT HUMIDITY	5%...95% rH non condensing / EN	5%...95% rH non condensing / EN
MAINTENANCE	Maintenance Free	Maintenance Free
MODE OF OPERATION	Type I / EN 60730-1	Type I / EN 60730-1
EMC	CE & ISO 9000 EN / EEC	CE & ISO 9000 EN / EEC

SA SERIES FAST RUNNING DAMPER ACTUATOR

**2 Point & 3 Point Control
20 Nm**

WIRING DIAGRAM SA...20 (S) POWER SUPPLY AC/DC 24V / AC 230V

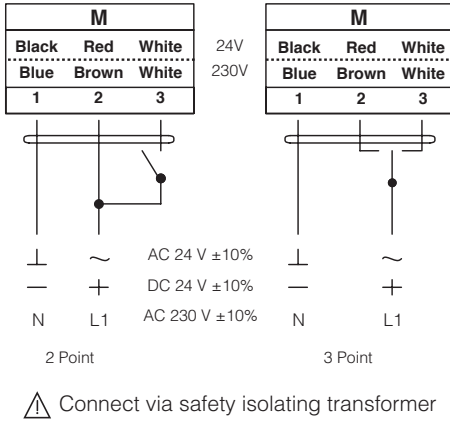

DIRECTION OF ROTATION SA...20 (S)

Default factory setting: CW.

Direction of rotation can be change by toggling between CW/CCW switch on the actuator's housing.

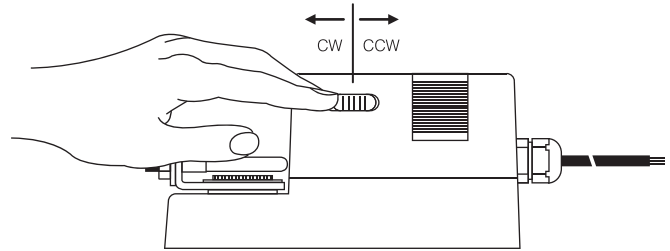

WIRING DIAGRAM SA...20 (S) AUXILIARY SWITCHES

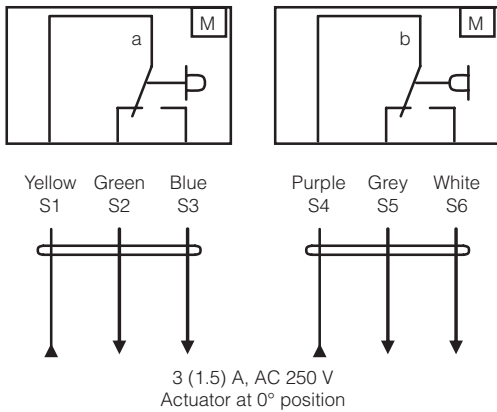

AUXILIARY SWITCH SA...20 (S)

Switch **a** factory-set at 5° and 85°.

The auxiliary switch can be optimally adjusted between 0°...90°.

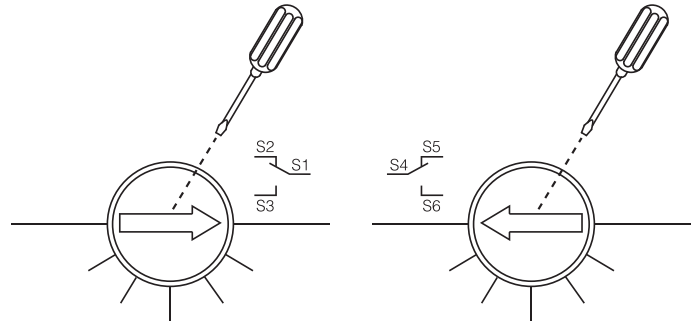

WIRING DIAGRAM SA...20 (S) PARALLEL CONNECTION

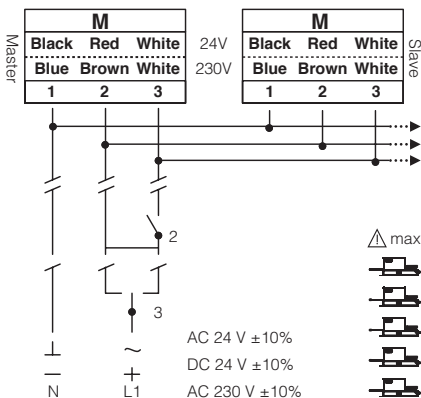

REMARK

Parallel connection of SA...20 (S) actuators are limited to 5. Power consumption must be observe.

ANGLE OF ROTATION LIMITING

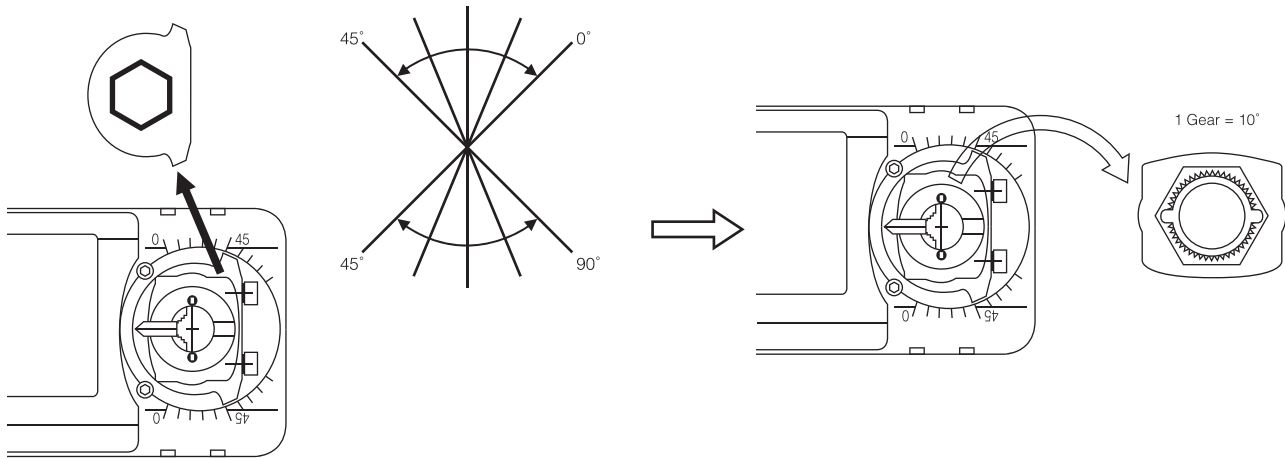

INSTALLATION / MOUNTING INSTRUCTION

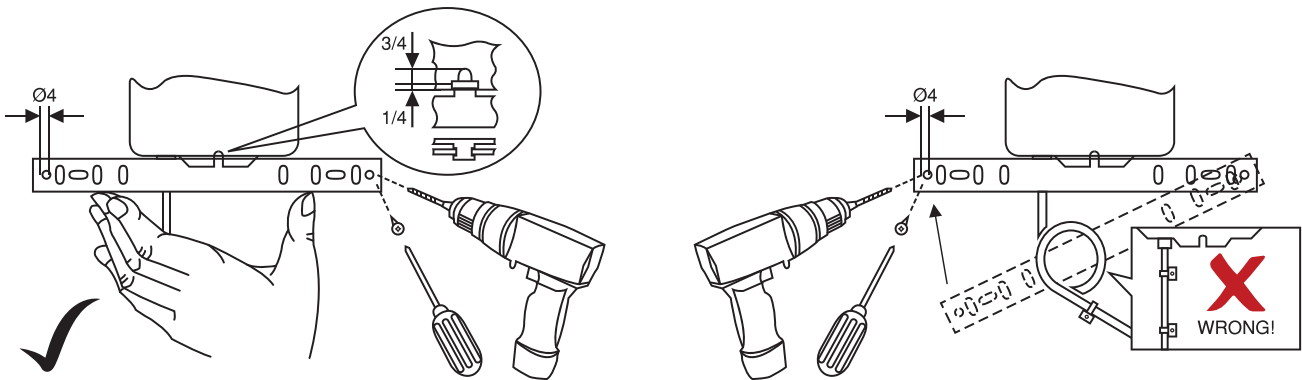

IMPORTANT REMARK

For special requirement, consult your local Swisotec's representative.



This actuator includes electrical and electronic components and may not be disposed as household garbage. Please consider the local valid legislation.



AC / DC 24 V: Connect via safety isolating transformer.
 AC 230 V: To isolate from the main power supply, the system must incorporate a device which disconnects the phase conductor (with at least a 3mm contact gap.)

The performance specifications are nominal and conform to acceptable industry standards. Swisotec shall not be liable for damages resulting from misapplication or misuse of its products.