

SSA SERIES FIRE & SMOKE DAMPER ACTUATOR

**3 Point Non Spring Return Control
15 Nm**

SSA...15S SERIES

SSA Non-Spring Return actuators are developed for use with fire and smoke damper. The actuator motorized the damper or other devices when power on.



PRODUCT FEATURE

- Torque 15 Nm
- Damper size 3.0 m²
- Power supply AC/DC 24V and AC 230 V
- Shaft dimensions - Form fit 12 mm square
- Adapter supplied for Form Fit 8 or 10 mm square
- Selectable direction of rotation of reversing actuator
- Actuator with 1 m cable connection
- 2 Fixed auxiliary switches
- Manual Over-ride by crank handle when required
- Anti-rotation bracket provided for stability

MODEL SELECTION TABLE

MODEL / TYPE	TORQUE	POWER SUPPLY	RUNNING TIME	AUXILIARY SWITCHES
SSA 1-15S	15 Nm	AC/DC 24 V \pm 10%	< 30 sec	2 x SPDT (Fixed)
SSA 2-15S	15 Nm	AC 230 V \pm 10%	< 30 sec	2 x SPDT (Fixed)

DIMENSION (mm)

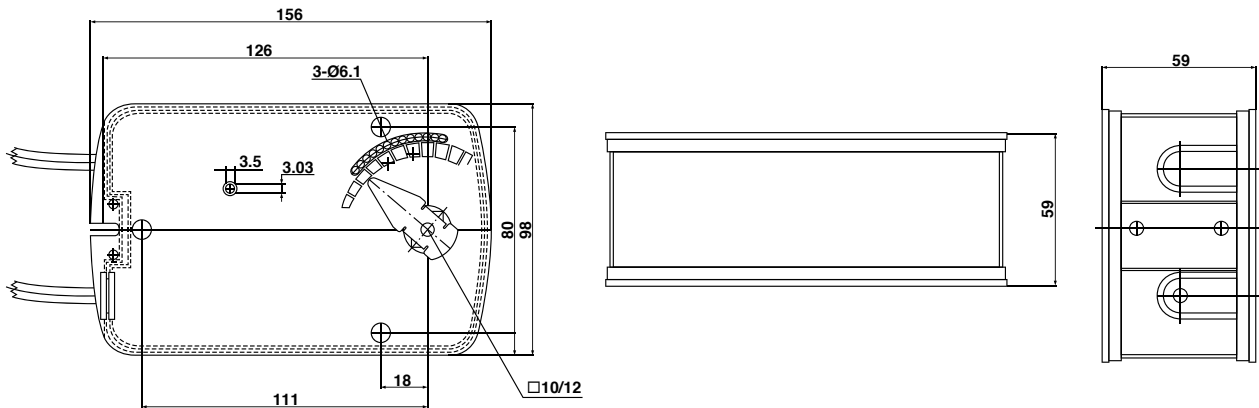

TECHNICAL SPECIFICATION

MODEL NUMBER	SSA 1-15S	SSA 2-15S
TORQUE	15 Nm	15 Nm
DAMPER SIZE	3.0 m ²	3.0 m ²
SHAFT DIMENSION	From Fit 12 mm square	From Fit 12 mm square
POWER SUPPLY	AC/DC 24 V ± 10%	AC 230 V ± 10%
FREQUENCY	50...60 Hz	50...60 Hz
CONTROL SIGNAL	3 point control	3 point control
POWER CONSUMPTION		
● OPERATING	8.2 W	5.2 W
● END POSITION	3.5 W	3.5 W
FOR WIRE SIZING	10.0 VA	10.0 VA
ELECTRICAL CONNECTION	1 m Cable	1 m Cable
AUXILIARY SWITCHES RATING	3 (1.5) A, AC 250 V	3 (1.5) A, AC 250 V
PROTECTION CLASS	Class II \square	Class II \square
ANGLE OF ROTATION	90° (95° mechanical)	90° (95° mechanical)
THERMAL TEMPERATURE TRIP	> 72°C	> 72°C
WEIGHT	1.8 Kg	1.9 Kg
LIFE CYCLE	60,000 Rotation	60,000 Rotation
SOUND LEVEL	45 dB	45 dB
IP PROTECTION	IP54	IP54
OPERATING TEMPERATURE	-20°...50° as per IEC 721-3-3	-20°...50° as per IEC 721-3-3
NON-OPERATING TEMPERATURE	-30°...+60° C / IEC 721-3-2	-30°...+60° C / IEC 721-3-2
AMBIENT HUMIDITY	5%...95% rH non condensing / EN	5%...95% rH non condensing / EN
MAINTENANCE	Maintenance Free	Maintenance Free
MODE OF OPERATION	Type I / EN 60730-1	Type I / EN 60730-1
EMC	CE, UL 873 & ISO 9000 EN / EEC	CE, UL 873 & ISO 9000 EN / EEC

SSA SERIES FIRE & SMOKE DAMPER ACTUATOR

**3 Point Non Spring Return Control
15 Nm**

WIRING DIAGRAM SSA...15S POWER SUPPLY AC/DC 24 V / AC 230V

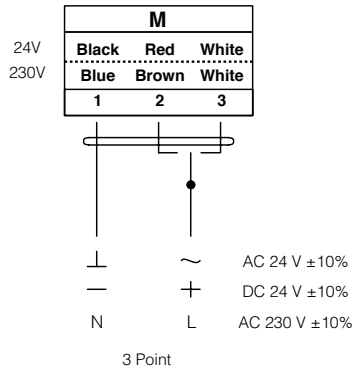

⚠ Connect via safety isolating transformer

DIRECTION OF ROTATION SSA...15S

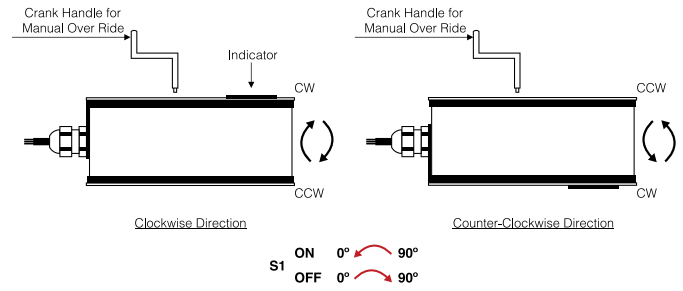

WIRING DIAGRAM SSA...15S AUXILIARY SWITCHES

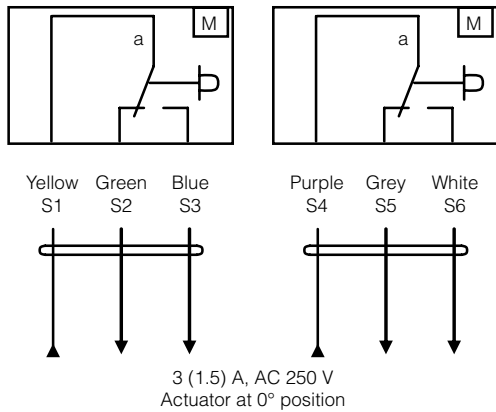

AUXILIARY SWITCHES SSA...15S

Auxiliary are fixed at 5° for switch (a) and 85° for switch (b)
Auxiliary switches are non adjustable.

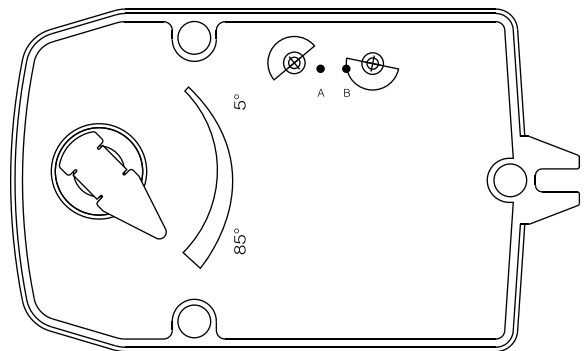

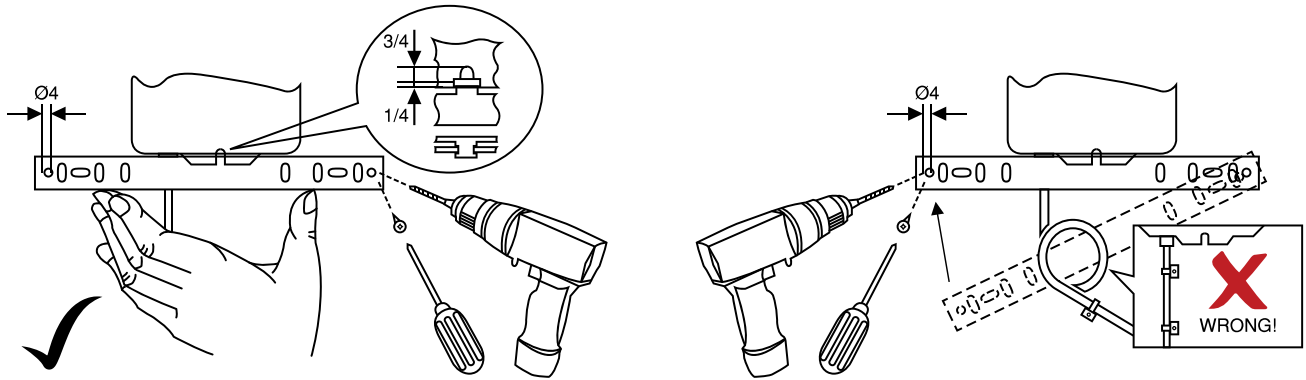

INSTALLATION / MOUNTING INSTRUCTION



IMPORTANT REMARK

For special requirement, consult your local NenuTec's representative.

  This actuator includes electrical and electronic components and may not be disposed as household garbage. Please consider the local valid legislation.

 AC / DC 24 V: Connect via safety isolating transformer.
AC 230 V: To isolate from the main power supply, the system must incorporate a device which disconnects the phase conductor (with at least a 3mm contact gap.)

The performance specifications are nominal and conform to acceptable industry standards. NENUTEC shall not be liable for damages resulting from misapplication or misuse of its products.